

Village of Bronxville

Solar Energy System Site Development Application

Solar Panel Application Energy Storage System

Project Name, If Applicable: Solar Panel Installation - Joseph Kochansky
Project Street Address: 21 Crows Nest Road, Bronxville, NY 10708
Section: 6.1 Block: 1 Lot(s): 15 Zone: AA

Plans Prepared By: Michael Miele
Address: 705 Oris Mills Rd.
City: New Windsor State: NY Zip: 12553
Phone #: 845-629-9693 Email: Mike Miele PE @ gmail.com

Owner: Joseph Kochansky
Address: 21 Crows Nest Road
City: Bronxville State: NY Zip: 10708
Phone #: 212-361-9690 Email: Jody.Kochansky@gmail.com

Zoning District: AA

Zoning Variances Required: None

County, State or Federal Permits Required: None

Proposed use(s) of site: Proposed 21.09KW Rooftop Solar System
consisting of (57) LG 370NIK-A6 Panels & (57)
IQ7+ micro inverters.

Anticipated construction time: As soon as permit is issued.

Office Use Only							
Date Received	Docket No.	Section	Block	Lot	Permit #	Fee Paid	Date Approved

Current land use of site: (Residential; Commercial; Undeveloped) Single family residential.

Current condition of site: (Building; Brush; ect.) developed single family residential.

Estimated cost of proposed improvements: \$ 56,500.00

Please provide total system capacity rating 21.09 KW

Describe Solar Energy System Proposed:

Proposed Rooftop solar system consisting of
(57) LG370N1K-A6 panels & (57) IQ7+ micro
Inverters

Owners Name: Joseph Kochanski

Owners Signature:

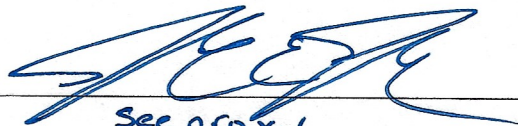
see proxy

Date: 6-8-22

January 18th , 2021

Village of Bronxville
Bronxville Zoning Board
200 Pondfield Rd
Bronxville, NY 10708

Re: Joseph Kochansky - 21 Crows Nest Rd, Bronxville, NY 10708
Single Family Residence, Rooftop Solar Installation
Village of Bronxville, County of Westchester, State of New York

Dear Zoning Board,

I am a neighbor of the above referenced property. I have reviewed the plans prepared by Michael E. Miele, PE for the installation of rooftop solar at the residence of Joseph Kochansky located at 21 Crows Nest Road, Bronxville, NY 10708.

I do **NOT** have any issue with Mr. Kochansky installing solar panels on his roof and I am for this progressive, energy conscious amendment to his property. I hope you consider these comments when making your decision and approve this project on the January 25th Zoning Board Meeting.

Thank you for your consideration,

TIM AND JILL WHIPPLE

Name

Signature

14 VILLAGE LANE

Address



FRONT OF HOUSE, PANELS ARE LOCATED ON REAR OF HOUSE, NOT VISIBLE FROM STREET

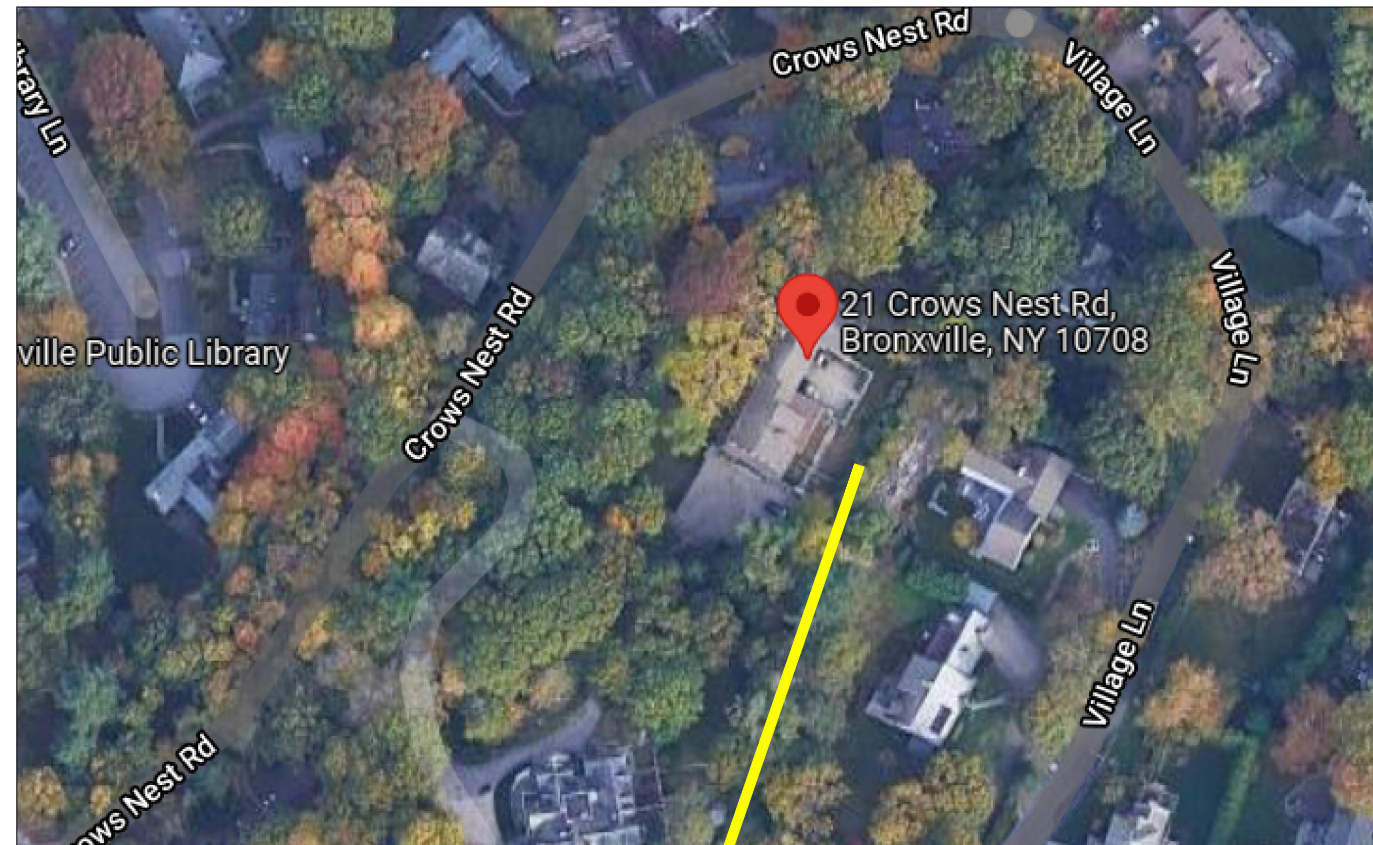
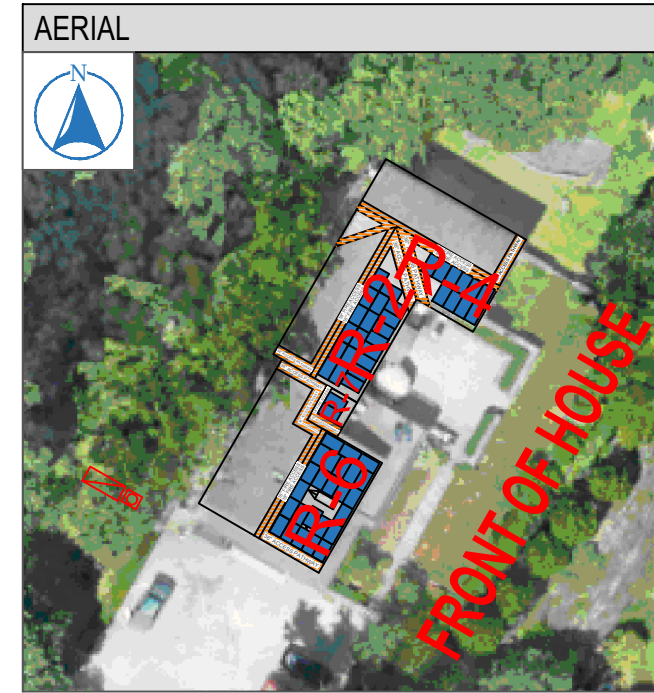

WITH EXISTING VEGETATION, PANELS NOT VISABLE FROM NEIGHBORS



50 MAIN STREET. #1000,
WHITE PLAINS, NY 10606
(914) 719-7786

KOCHANSKY RESIDENCE

21 CROWS NEST ROAD
BRONXVILLE, NY 10708
VILLAGE OF BRONXVILLE
S: 6.1 B: 1 L: 15

PROJECT DATA: #214729
 INVERTER: (57) ENPHASE IQ7PLUS-72-US
 MODULES: (57) LG370N1K-A6
 RACKING: IRON RIDGE XR100
 WATTAGE: 21,090
 ROOF TYPE: COMPOSITION SHINGLES
 WIND LOAD: -33 & -18 PSF @ 130MPH
 FASTENER: USE 5/16" DIA. 5" LAGS



MICHAEL E. MIELE, PE
 Licensed Professional Engineer
 705 Orrs Mills Road
 New Windsor, NY 12553
 TELEPHONE: (845) 629.9693
 EMAIL: MieleEngineering@gmail.com



ALTERATION OF THIS DOCUMENT EXCEPT BY A
LICENSED PROFESSIONAL IS ILLEGAL

PAPER SIZE: 11" x 17" (ANSI B)

DATE: 08/05/2021
 DESIGN BY: MW
 CHECKED BY: MEM
 REVISIONS:

2020 RESIDENTIAL CODE OF NEW YORK STATE, 2020 ENERGY CONSERVATION CODE OF NEW YORK STATE,
VILLAGE OF BRONXVILLE CODE, 2017 NATIONAL ELECTRIC CODE. ASCE7-16.

ELEVATION

EV-1

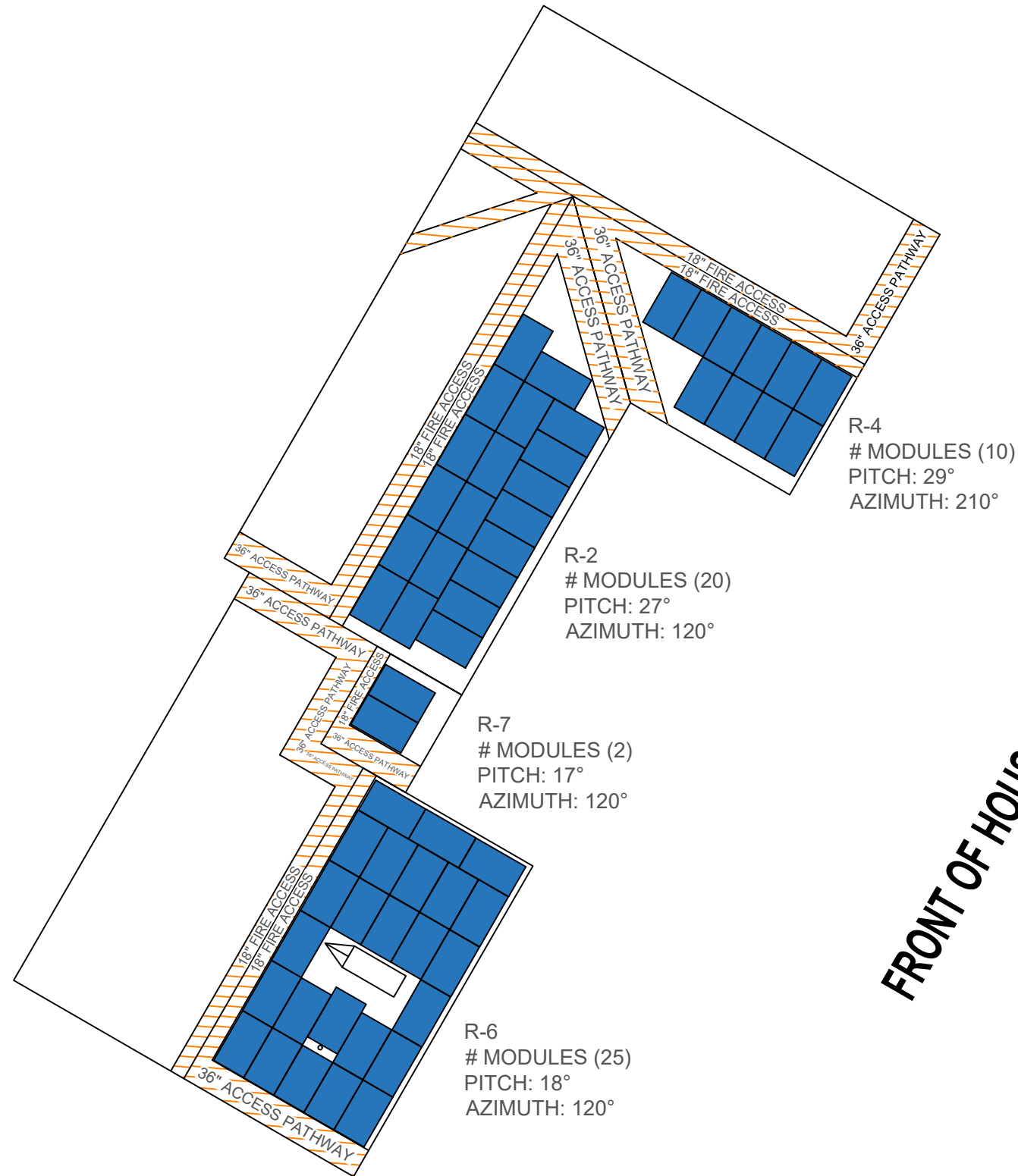

FRONT OF HOUSE

AERIAL



SHEET INDEX

- S-1 SITE PLAN
- S-2 DETAILS
- E-1 ELECTRICAL PLAN
- L-1 MOUNTING PLAN

GENERAL NOTES

- ENPHASE IQ7 PLUS MICRO INVERTER LOCATED ON ROOF BEHIND EACH MODULE.
- FIRST RESPONDER ACCESS MAINTAINED AND FROM ADJACENT ROOF.
- WIRE RUN FROM ARRAY TO CONNECTION IS 40 FEET.
- COGEN DISCONNECT IS LOCATED ADJACENT TO UTILITY METER.
- LAYOUT SUBJECT TO CHANGE BASED ON SITE CONDITIONS AT DATE OF INSTALL

LEGEND

- GROUND ACCESS POINT
- COGEN DISCONNECT
- UTILITY METER

REPRESENTS ALL FIRE CLEARANCE INCLUDING ALTERNATIVE METHODS

FIRST RESPONDER ACCESS
MINIMUM OF 36" UNOBSTRUCTED AS PER
THE 2020 RESIDENTIAL CODE OF NYS

2020 RESIDENTIAL CODE OF NEW YORK STATE, 2020 ENERGY CONSERVATION CODE OF NEW YORK STATE,
VILLAGE OF BRONXVILLE CODE, 2017 NATIONAL ELECTRIC CODE. ASCE7-16.



50 MAIN STREET. #1000,
WHITE PLAINS, NY 10606
(914) 719-7786

**KOCHANSKY
RESIDENCE**

21 CROWS NEST ROAD
BRONXVILLE, NY 10708
VILLAGE OF BRONXVILLE
S: 6.1 B: 1 L: 15

PROJECT DATA: #214729

INVERTER: (57) ENPHASE IQ7PLUS-72-2-US
MODULES: (57) LG370N1K-A6
RACKING: IRON RIDGE XR100
WATTAGE: 21,090
ROOF TYPE: COMPOSITION SHINGLES
WIND LOAD: -33 & -18 PSF @ 130MPH
FASTENER: USE 5/16" DIA. 5" LAGS



MICHAEL E. MIELE, PE

Licensed Professional Engineer
705 Orrs Mills Road
New Windsor, NY 12553
TELEPHONE: (845) 629.9693
EMAIL: MieleEngineering@gmail.com



ALTERATION OF THIS DOCUMENT EXCEPT BY A
LICENSED PROFESSIONAL IS ILLEGAL

PAPER SIZE: 11" x 17" (ANSI B)

DATE: 08/05/2021
DESIGN BY: MW
CHECKED BY: MEM
REVISIONS:

SITE PLAN

S-1

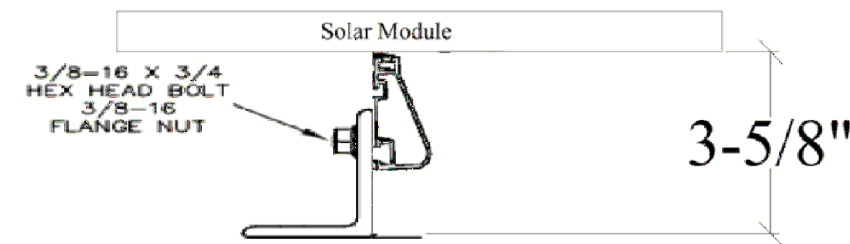
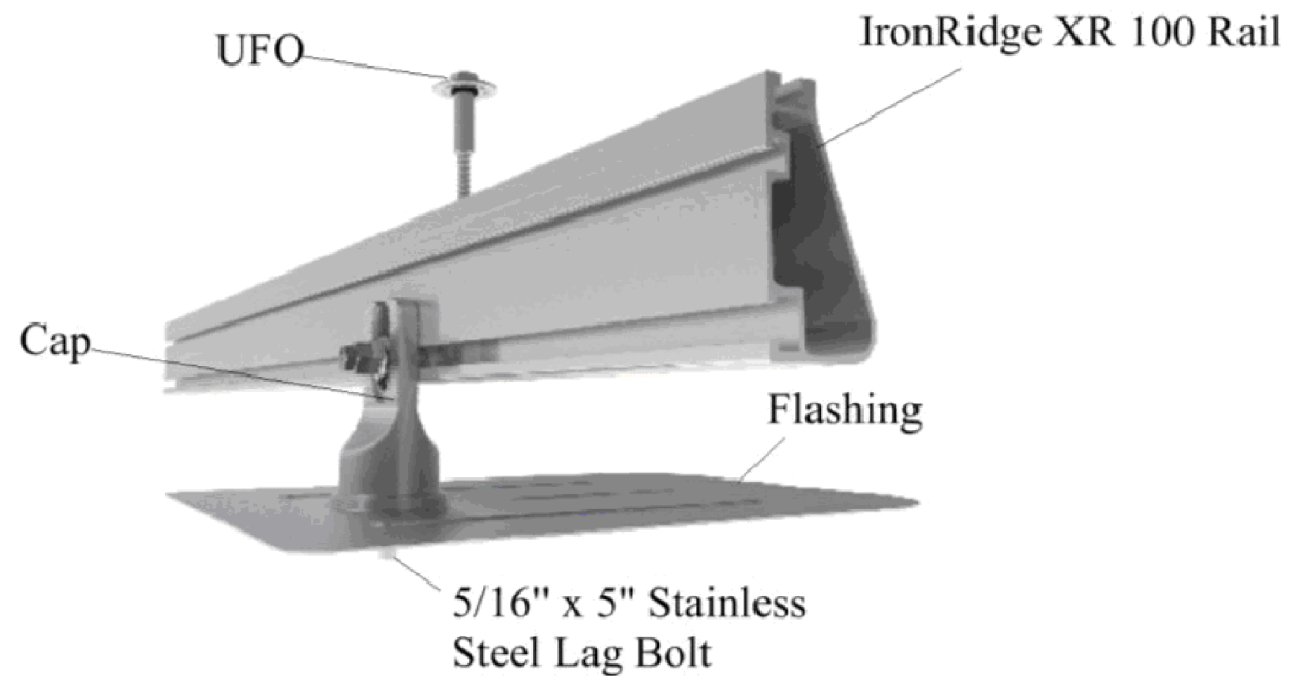
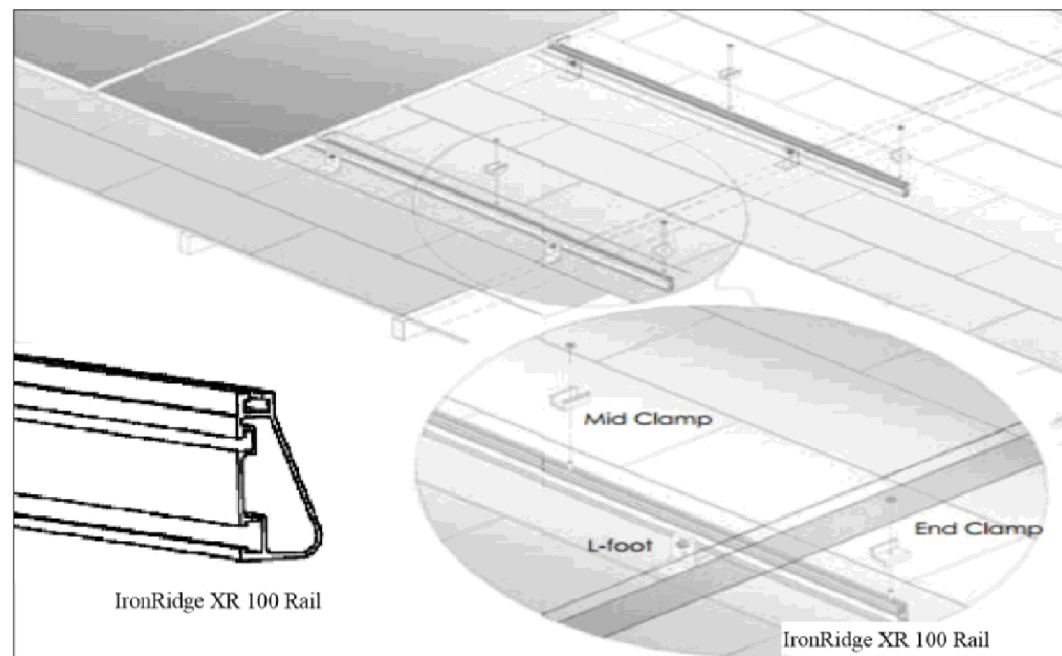

GENERAL NOTES:

- L FEET ARE SECURED TO ROOF RAFTERS @ 80" O.C.
- USING 5/16" x 5" STAINLESS STEEL LAG BOLTS.
- SUBJECT ROOF HAS 1 LAYER.
- ALL PENETRATIONS ARE SEALED AND FLASHED.

ROOF	PITCH	RIDGE	RAFTERS	LENGTH	OVERHANG	NOTES
2	27°	2"x12"	2"x10"@16"O.C.	15'-8"	18"	
4	29°	2"x12"	2"x12"@16"O.C.	14'-4"	18"	
6	18°	2"x12"	2"x12"@16"O.C.	19'-2"	18"	
7	17°	2"x12"	2"x10"@16"O.C.	12'-1"	18"	

DESIGNED AS PER ASCE 7-10
 MODULES MOUNTED FLUSH TO ROOF
 NO HIGHER THAN 6" ABOVE ROOF SURFACE

2020 RESIDENTIAL CODE OF NEW YORK STATE, 2020 ENERGY CONSERVATION CODE OF NEW YORK STATE,
 VILLAGE OF BRONXVILLE CODE, 2017 NATIONAL ELECTRIC CODE. ASCE7-16.



50 MAIN STREET. #1000,
 WHITE PLAINS, NY 10606
 (914) 719-7786

**KOCHANSKY
 RESIDENCE**

21 CROWS NEST ROAD
 BRONXVILLE, NY 10708
 VILLAGE OF BRONXVILLE
 S: 6.1 B: 1 L: 15

PROJECT DATA: #214729
 INVERTER: (57) ENPHASE IQ7PLUS-72-2-US
 MODULES: (57) LG370N1K-A6
 RACKING: IRON RIDGE XR100
 WATTAGE: 21,090
 ROOF TYPE: COMPOSITION SHINGLES
 WIND LOAD: -33 & -18 PSF @ 130MPH
 FASTENER: USE 5/16" DIA. 5" LAGS



MICHAEL E. MIELE, PE
 Licensed Professional Engineer
 705 Orrs Mills Road
 New Windsor, NY 12553
 TELEPHONE: (845) 629.9693
 EMAIL: MieleEngineering@gmail.com



ALTERATION OF THIS DOCUMENT EXCEPT BY A
 LICENSED PROFESSIONAL IS ILLEGAL

PAPER SIZE: 11" x 17" (ANSI B)

DATE: 08/05/2021
 DESIGN BY: MW
 CHECKED BY: MEM
 REVISIONS:

DETAILS

S-2

KOCHANSKY RESIDENCE

21 CROWS NEST ROAD
BRONXVILLE, NY 10708
VILLAGE OF BRONXVILLE
S: 6.1 B: 1 L: 15

PROJECT DATA: #214729

INVERTER: (57) ENPHASE IQ7PLUS-72-2-US
MODULES: (57) LG370N1K-A6
RACKING: IRON RIDGE XR100
WATTAGE: 21,090
ROOF TYPE: COMPOSITION SHINGLES
WIND LOAD: -33 & -18 PSF @ 130MPH
FASTENER: USE 5/16" DIA. 5" LAGS



MICHAEL E. MIELE, PE
Licensed Professional Engineer
705 Orrs Mills Road
New Windsor, NY 12553
TELEPHONE: (845) 629.9693
EMAIL: MieleEngineering@gmail.com



ALTERATION OF THIS DOCUMENT EXCEPT BY A LICENSED PROFESSIONAL IS ILLEGAL

PAPER SIZE: 11" x 17" (ANSI B)

DATE: 08/05/2021
DESIGN BY: MW
CHECKED BY: MEM
REVISIONS:

PHOTOVOLTAICS:
(57) LG370N1K-A6

INVERTERS:
(57) ENPHASE IQ7PLUS-72-2-US

CIRCUITS:
(2) CIRCUITS OF (12) MODULES
(3) CIRCUITS OF (11) MODULES

NEMA 3R
JUNCTION BOX

BLACK - L1
RED - L2
WHITE - NEUTRAL
GREEN - GROUND

ENGAGE CABLE

#12 AWG THWN FOR HOME RUNS UNDER 100'
#10 AWG THWN FOR HOME RUNS OVER 100'
(1) LINE 1
(1) LINE 2
(1) NEUTRAL
(1) GROUND
PER CIRCUIT
IN 1" OR 1 1/4" PVC CONDUIT

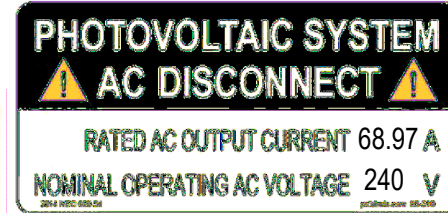
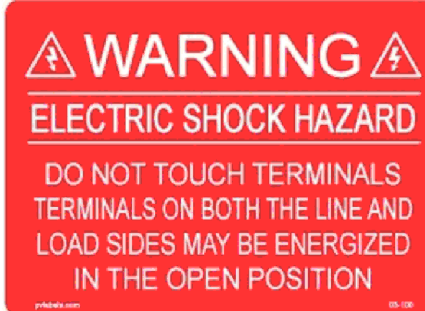

METER
ACCT#: 52-2216-0170-0004-4
METER#: 11022683

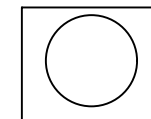

LINE SIDE TAP

125A LOAD CENTER
(1) - 20A BREAKER
PER CIRCUIT
DISCONNECT

100A FUSED SERVICE
RATED DISCONNECT
90A FUSE

MAIN SERVICE
200A
AC DISTRIBUTION PANEL
OR SUB PANEL

#4 AWG THWN
(1) LINE 1
(1) LINE 2
(1) NEUTRAL
(1) EGC
(1) GEC
IN 1 1/4" PVC CONDUIT

#4 AWG THWN
(1) LINE 1
(1) LINE 2
(1) NEUTRAL
(1) EGC
(1) GEC
IN 1 1/4" PVC CONDUIT



AC COMBINER:
1-PHASE, MAIN LUG LOAD CENTER, 125A

NOTE:
ALL WIRING TO MEET THE 2017 NEC AND 2020 ENERGY CODE
100A FUSED SERVICE RATED DISCONNECT

2020 RESIDENTIAL CODE OF NEW YORK STATE, 2020 ENERGY CONSERVATION CODE OF NEW YORK STATE,
VILLAGE OF BRONXVILLE CODE, 2017 NATIONAL ELECTRIC CODE. ASCE7-16.

Michael E. Miele, PE

Licensed Professional Engineer

Licensed In New York, New Jersey, Connecticut & California

New York License # 079676

New Jersey License # 44042

Connecticut License # 23158

California License # 31508

August 24, 2021

Village of Bronxville Building Department

The Office of the Building Inspector

200 Pondfield Road

Bronxville, New York 1070

Re: Joseph Kochansky - 1 Crows Nest Road, Bronxville, NY 10708
Single Family Residence, Solar Panel Loading Certification
Village of Bronxville, County of Westchester, State of New York

Dear Building Department

I am the engineer of record for the above referenced project. I have prepared the attached plans dated August 5, 2021 that consists of the installation of (57) LG370N1K-A6W solar panels at the above referenced location.

I can herby certify that the existing roof structure combined with the additional weight of the solar panels meets the requirements of The 2020 Residential Code of New York State, Publication Date, November 2019.

The design loads were as follows,

Roof Design Load: 40psf live load

Wind Design Load: 120mph

No additional structural members were required.

The roof is currently framed with 2x10 wood framing @ 16" O.C. The roof structural members are in compliance with ASCE 7-16 for deflection and acceptable bending stress.

If you have any questions, please feel free to call me at any time. Thanks in advance.

Sincerely Yours,



Michael E. Miele, PE



KOCHANSKY RESIDENCE

21 CROWS NEST ROAD
BRONXVILLE, NY 10708
VILLAGE OF BRONXVILLE
S: 6.1 B: 1 L: 15

PROJECT DATA: #214729
INVERTER: (57) ENPHASE IQ7PLUS-72-2-US
MODULES: (57) LG370N1K-A6
RACKING: IRON RIDGE XR100
WATTAGE: 21,090
ROOF TYPE: COMPOSITION SHINGLES
WIND LOAD: -33 & -18 PSF @ 130MPH
FASTENER: USE 5/16" DIA. 5" LAGS



MICHAEL E. MIELE, PE
Licensed Professional Engineer
705 Orrs Mills Road
New Windsor, NY 12553
TELEPHONE: (845) 629.9693
EMAIL: MieleEngineering@gmail.com



ALTERATION OF THIS DOCUMENT EXCEPT BY A LICENSED PROFESSIONAL IS ILLEGAL

PAPER SIZE: 11" x 17" (ANSI B)

DATE: 08/05/2021
DESIGN BY: MW
CHECKED BY: MEM
REVISIONS:

MOUNTING PLAN

L-1

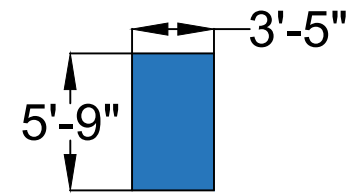

LG370N1K-A6
PANEL DIMENSIONS:

SCALE: 1/8"=1'-0"

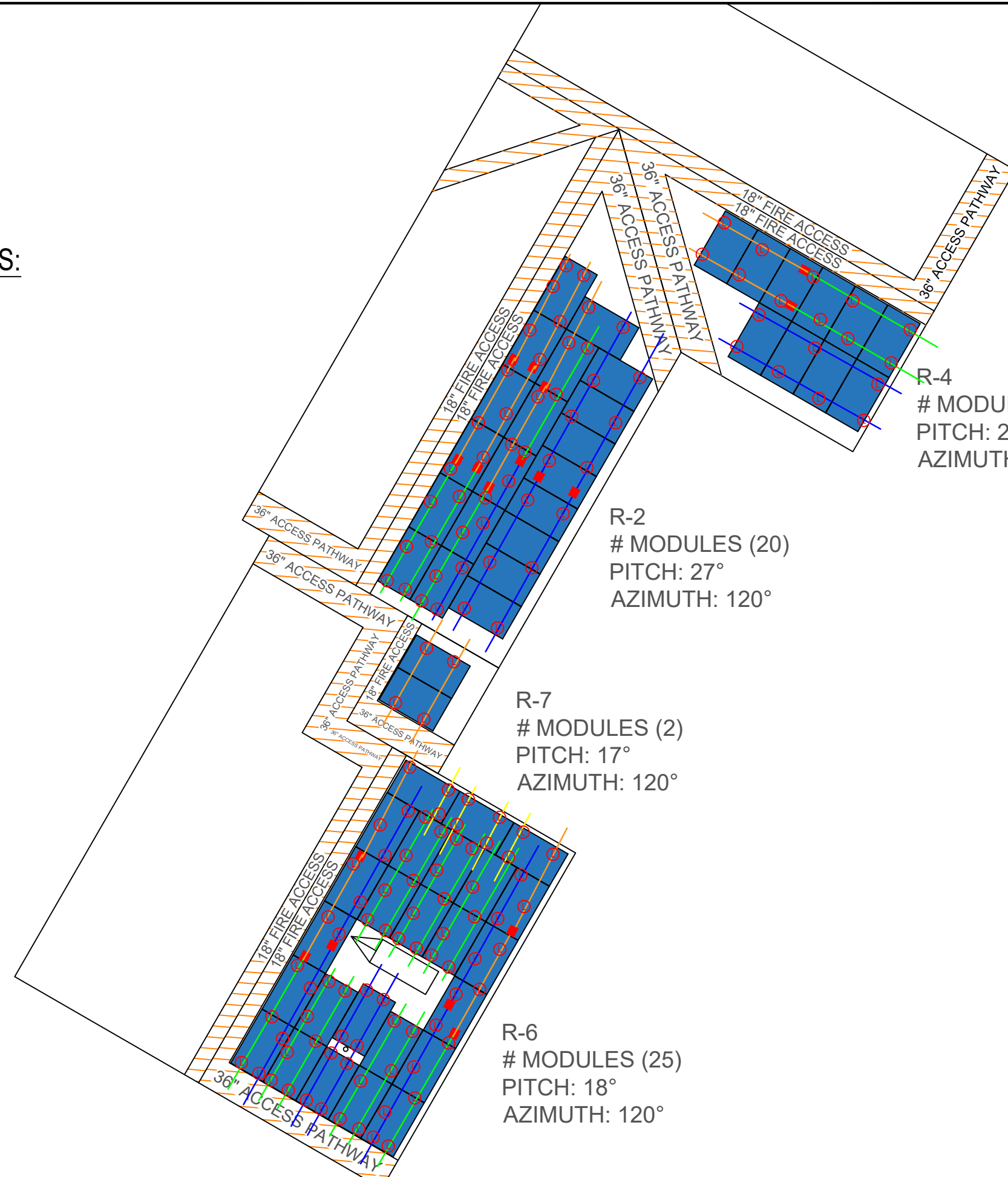

R-4
MODULES (10)
PITCH: 29°
AZIMUTH: 210°

R-2
MODULES (20)
PITCH: 27°
AZIMUTH: 120°

R-7
MODULES (2)
PITCH: 17°
AZIMUTH: 120°

R-6
MODULES (25)
PITCH: 18°
AZIMUTH: 120°

- 17' ————— 10
- 14' ————— 20
- 11' ————— 14
- 7' ————— 0
- 4' ————— 0
- SPLICE BAR 17
- ⊙ PENETRATIONS 162
- UFO 140
- 40MM SLEEVE 56
- END CAPS 56
- CONSUMPTION
- CRITTER GUARD 330'



Built for solar's toughest roofs.

IronRidge builds the strongest roof mounting system in solar. Every component has been tested to the limit and proven in extreme environments.

Our rigorous approach has led to unique structural features, such as curved rails and reinforced flashings, and is also why our products are fully certified, code compliant and backed by a 20-year warranty.



Strength Tested

All components evaluated for superior structural performance.



PE Certified

Pre-stamped engineering letters available in most states.



Class A Fire Rating

Certified to maintain the fire resistance rating of the existing roof.



Design Software

Online tool generates a complete bill of materials in minutes.



Integrated Grounding

UL 2703 system eliminates separate module grounding components.



20 Year Warranty

Twice the protection offered by competitors.

XR Rails

XR10 Rail



A low-profile mounting rail for regions with light snow.

- 6' spanning capability
- Moderate load capability
- Clear & black anod. finish

XR100 Rail



The ultimate residential solar mounting rail.

- 8' spanning capability
- Heavy load capability
- Clear & black anod. finish

XR1000 Rail



A heavyweight mounting rail for commercial projects.

- 12' spanning capability
- Extreme load capability
- Clear anodized finish

Internal Splices



All rails use internal splices for seamless connections.

- Self-tapping screws
- Varying versions for rails
- Grounding Straps offered

Attachments

FlashFoot



Anchor, flash, and mount with all-in-one attachments.

- Ships with all hardware
- IBC & IRC compliant
- Certified with XR Rails

Slotted L-Feet



Drop-in design for rapid rail attachment.

- High-friction serrated face
- Heavy-duty profile shape
- Clear & black anod. finish

Standoffs



Raise flush or tilted systems to various heights.

- Works with vent flashing
- Ships pre-assembled
- 4" and 7" Lengths

Tilt Legs



Tilt assembly to desired angle, up to 45 degrees.

- Attaches directly to rail
- Ships with all hardware
- Fixed and adjustable

Clamps & Grounding

End Clamps



Slide in clamps and secure modules at ends of rails.

- Mill finish & black anod.
- Sizes from 1.22" to 2.3"
- Optional Under Clamps

Grounding Mid Clamps



Attach and ground modules in the middle of the rail.

- Parallel bonding T-bolt
- Reusable up to 10 times
- Mill & black stainless

T-Bolt Grounding Lugs



Ground system using the rail's top slot.

- Easy top-slot mounting
- Eliminates pre-drilling
- Swivels in any direction

Accessories



Provide a finished and organized look for rails.

- Snap-in Wire Clips
- Perfected End Caps
- UV-protected polymer

Free Resources



Design Assistant

Go from rough layout to fully engineered system. For free.

[Go to IronRidge.com/rm](http://IronRidge.com/rm)



NABCEP Certified Training

Earn free continuing education credits, while learning more about our systems.

[Go to IronRidge.com/training](http://IronRidge.com/training)

Enphase IQ 7 and IQ 7+ Microinverters

The high-powered smart grid-ready **Enphase IQ 7 Micro™** and **Enphase IQ 7+ Micro™** dramatically simplify the installation process while achieving the highest system efficiency.

Part of the Enphase IQ System, the IQ 7 and IQ 7+ Microinverters integrate with the Enphase IQ Envoy™, Enphase IQ Battery™, and the Enphase Enlighten™ monitoring and analysis software.

IQ Series Microinverters extend the reliability standards set forth by previous generations and undergo over a million hours of power-on testing, enabling Enphase to provide an industry-leading warranty of up to 25 years.



Easy to Install

- Lightweight and simple
- Faster installation with improved, lighter two-wire cabling
- Built-in rapid shutdown compliant (NEC 2014 & 2017)

Productive and Reliable

- Optimized for high powered 60-cell and 72-cell* modules
- More than a million hours of testing
- Class II double-insulated enclosure
- UL listed

Smart Grid Ready

- Complies with advanced grid support, voltage and frequency ride-through requirements
- Remotely updates to respond to changing grid requirements
- Configurable for varying grid profiles
- Meets CA Rule 21 (UL 1741-SA)

* The IQ 7+ Micro is required to support 72-cell modules.



Enphase IQ 7 and IQ 7+ Microinverters

INPUT DATA (DC)	IQ7-60-2-US / IQ7-60-B-US		IQ7PLUS-72-2-US / IQ7PLUS-72-B-US	
Commonly used module pairings ¹	235 W - 350 W +		235 W - 440 W +	
Module compatibility	60-cell PV modules only		60-cell and 72-cell PV modules	
Maximum input DC voltage	48 V		60 V	
Peak power tracking voltage	27 V - 37 V		27 V - 45 V	
Operating range	16 V - 48 V		16 V - 60 V	
Min/Max start voltage	22 V / 48 V		22 V / 60 V	
Max DC short circuit current (module I _{sc})	15 A		15 A	
Overvoltage class DC port	II		II	
DC port backfeed current	0 A		0 A	
PV array configuration	1 x 1 ungrounded array; No additional DC side protection required; AC side protection requires max 20A per branch circuit			
OUTPUT DATA (AC)	IQ 7 Microinverter		IQ 7+ Microinverter	
Peak output power	250 VA		295 VA	
Maximum continuous output power	240 VA		290 VA	
Nominal (L-L) voltage/range ²	240 V / 211-264 V	208 V / 183-229 V	240 V / 211-264 V	208 V / 183-229 V
Maximum continuous output current	1.0 A (240 V)	1.15 A (208 V)	1.21 A (240 V)	1.39 A (208 V)
Nominal frequency	60 Hz		60 Hz	
Extended frequency range	47 - 68 Hz		47 - 68 Hz	
AC short circuit fault current over 3 cycles	5.8 Arms		5.8 Arms	
Maximum units per 20 A (L-L) branch circuit ³	16 (240 VAC)	13 (208 VAC)	13 (240 VAC)	11 (208 VAC)
Overvoltage class AC port	III		III	
AC port backfeed current	0 A		0 A	
Power factor setting	1.0		1.0	
Power factor (adjustable)	0.7 leading ... 0.7 lagging		0.7 leading ... 0.7 lagging	
EFFICIENCY	@240 V	@208 V	@240 V	@208 V
Peak CEC efficiency	97.6 %	97.6 %	97.5 %	97.3 %
CEC weighted efficiency	97.0 %	97.0 %	97.0 %	97.0 %
MECHANICAL DATA				
Ambient temperature range	-40°C to +65°C			
Relative humidity range	4% to 100% (condensing)			
Connector type (IQ7-60-2-US & IQ7PLUS-72-2-US)	MC4 (or Amphenol H4 UTX with additional Q-DCC-5 adapter)			
Connector type (IQ7-60-B-US & IQ7PLUS-72-B-US)	Friends PV2 (MC4 intermateable). Adaptors for modules with MC4 or UTX connectors: - PV2 to MC4: order ECA-S20-S22 - PV2 to UTX: order ECA-S20-S25			
Dimensions (WxHxD)	212 mm x 175 mm x 30.2 mm (without bracket)			
Weight	1.08 kg (2.38 lbs)			
Cooling	Natural convection - No fans			
Approved for wet locations	Yes			
Pollution degree	PD3			
Enclosure	Class II double-insulated, corrosion resistant polymeric enclosure			
Environmental category / UV exposure rating	NEMA Type 6 / outdoor			
FEATURES				
Communication	Power Line Communication (PLC)			
Monitoring	Enlighten Manager and MyEnlighten monitoring options. Both options require installation of an Enphase IQ Envoy.			
Disconnecting means	The AC and DC connectors have been evaluated and approved by UL for use as the load-break disconnect required by NEC 690.			
Compliance	CA Rule 21 (UL 1741-SA) UL 62109-1, UL1741/IEEE1547, FCC Part 15 Class B, ICES-0003 Class B, CAN/CSA-C22.2 NO. 107.1-01 This product is UL Listed as PV Rapid Shut Down Equipment and conforms with NEC-2014 and NEC-2017 section 690.12 and C22.1-2015 Rule 64-218 Rapid Shutdown of PV Systems, for AC and DC conductors, when installed according manufacturer's instructions.			

1. No enforced DC/AC ratio. See the compatibility calculator at <https://enphase.com/en-us/support/module-compatibility>.

2. Nominal voltage range can be extended beyond nominal if required by the utility.

3. Limits may vary. Refer to local requirements to define the number of microinverters per branch in your area.

To learn more about Enphase offerings, visit enphase.com



LG NeON[®] 2 Black

LG370N1K-A6

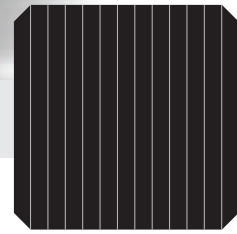

60

370W

The LG NeON[®] 2 is LG's best selling solar module and one of the most powerful and versatile modules on the market today. The cells are designed to appear all-black at a distance, and the performance warranty guarantees 90.6% of labeled power output at 25 years.

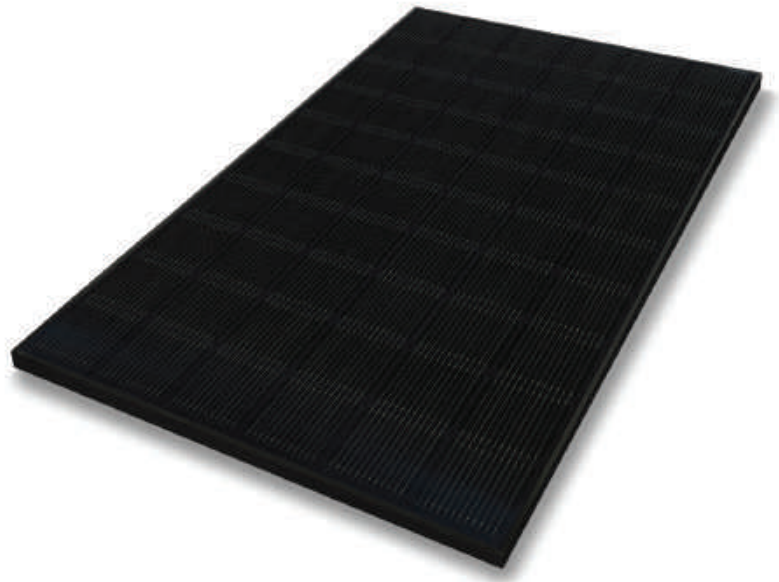

Features



Enhanced Performance Warranty

LG NeON[®] 2 Black has an enhanced performance warranty. After 25 years, LG NeON[®] 2 Black is guaranteed at least 90.6% of initial performance.



25-Year Limited Product Warranty

The NeON[®] 2 Black is covered by a 25-year limited product warranty. In addition, up to \$450 of labor costs will be covered in the rare case that a module needs to be repaired or replaced.



Solid Performance on Hot Days

LG NeON[®] 2 Black performs well on hot days due to its low temperature coefficient.



Roof Aesthetics

LG NeON[®] 2 Black has been designed with aesthetics in mind using thinner wires that appear all black at a distance.

When you go solar, ask for the brand you can trust: LG Solar

About LG Electronics USA, Inc.

LG Electronics is a global leader in electronic products in the clean energy markets by offering solar PV panels and energy storage systems. The company first embarked on a solar energy source research program in 1985, supported by LG Group's vast experience in the semi-conductor, LCD, chemistry and materials industries. In 2010, LG Solar successfully released its first MonoX[®] series to the market, which is now available in 32 countries. The NeON[®] (previous MonoX[®] NeON), NeON[®]2, NeON[®]2 BiFacial won the "Intersolar AWARD" in 2013, 2015 and 2016, which demonstrates LG's leadership and innovation in the solar industry.



LG370N1K-A6

General Data

Cell Properties (Material/Type)	Monocrystalline/N-type
Cell Maker	LG
Cell Configuration	60 Cells (6 x 10)
Number of Busbars	12EA
Module Dimensions (L x W x H)	1,740mm x 1,042mm x 40 mm
Weight	18.6 kg
Glass (Material)	Tempered Glass with AR coating
Backsheet (Color)	Black
Frame (Material)	Anodized Aluminium
Junction Box (Protection Degree)	IP 68 with 3 Bypass Diodes
Cables (Length)	1,100mm x 2EA
Connector (Type/Maker)	MC 4/MC

Certifications and Warranty

Certifications*	IEC 61215-1/-1-1/2 : 2016, IEC 61730-1/2 : 2016, UL 61730-1 : 2017, UL 61730-2 : 2017 ISO 9001, ISO 14001, ISO 50001 OHSAS 18001
Salt Mist Corrosion Test	IEC 61701:2012 Severity 6
Ammonia Corrosion Test	IEC 62716:2013
Module Fire Performance	Type 2 (UL 61730)
Fire Rating	Class C (UL 790, ULC/ORD C 1703)
Solar Module Product Warranty	25 Year Limited
Solar Module Output Warranty	Linear Warranty*

*Improved: 1st year 98.5%, from 2-24th year: -0.33%/year down, 90.6% at year 25

Temperature Characteristics

NMOT*	[°C]	42 ± 3
P _{max}	[%/°C]	-0.35
V _{oc}	[%/°C]	-0.26
I _{sc}	[%/°C]	0.03

*NMOT (Nominal Module Operating Temperature): Irradiance 800 W/m², Ambient temperature 20°C, Wind speed 1 m/s, Spectrum AM 1.5

Electrical Properties (NMOT)

Model	LG370N1K-A6	
Maximum Power (P _{max})	[W]	277
MPP Voltage (V _{mpp})	[V]	33.3
MPP Current (I _{mpp})	[A]	8.32
Open Circuit Voltage (V _{oc})	[V]	39.4
Short Circuit Current (I _{sc})	[A]	8.81

I-V Curves

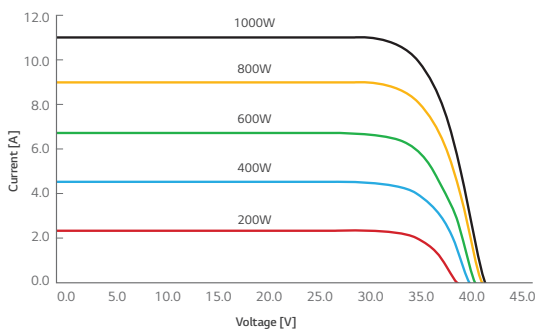

Electrical Properties (STC*)

Model	LG370N1K-A6	
Maximum Power (P _{max})	[W]	370
MPP Voltage (V _{mpp})	[V]	35.5
MPP Current (I _{mpp})	[A]	10.43
Open Circuit Voltage (V _{oc} ± 5%)	[V]	41.9
Short Circuit Current (I _{sc} ± 5%)	[A]	10.96
Module Efficiency	[%]	20.4
Power Tolerance	[%]	0 ~ +3

*STC (Standard Test Condition): Irradiance 1000 W/m², cell temperature 25°C, AM 1.5
Measurement Tolerance of P_{max}: ± 3%

Operating Conditions

Operating Temperature	[°C]	-40 ~ +85
Maximum System Voltage	[V]	1,000 (UL/IEC)
Maximum Series Fuse Rating	[A]	20
Mechanical Test Load* (Front)	[Pa/psf]	5,400
Mechanical Test Load* (Rear)	[Pa/psf]	4,000

*Based on IEC 61215-2 : 2016 (Test Load = Design Load x Safety Factor (1.5))
Mechanical Test Loads 6,000Pa/5,400Pa based on IEC 61215:2005

Packaging Configuration

Number of Modules per Pallet	[EA]	25
Number of Modules per 40' Container	[EA]	650
Number of Modules per 53' Container	[EA]	850
Packaging Box Dimensions (L x W x H)	[mm]	1,790 x 1,120 x 1,213
Packaging Box Dimensions (L x W x H)	[in]	70.5 x 44.1 x 47.8
Packaging Box Gross Weight	[kg]	500
Packaging Box Gross Weight	[lb]	1,102

Dimensions (mm/inch)

